

Light & Frame
**20
22**

This
is **Light
& Frame.**

TEXTILE COVERS



Light & Frame

ONE
TWO **SEE**

TREVISION

Textile covers with profile

TREVISION



Textile covers with profile.

Inputs from the international market and continuous product development in the area of “Light, Frame and Print” ensure that we can respond immediately to changing requirements and offer suitable product solutions with profile. In addition to the continuous further development of our versatile profiles, we also offer corresponding accessory products and intelligent overall solutions in the area of “Light, Frame and Print”. Expert advice on our profiles, flexible service and fast delivery are the hallmarks of Trevision.

The production of the products developed in Austria takes place under strictest quality conditions within the EU. Thus, we ensure consistently high quality in all our profiles for your unprecedented visual communication indoors and outdoors, in trade fair and store construction, store design and architecture. Our profile systems offer a high degree of flexibility and ensure quick interchangeability of subjects.

The principle of project solutions with textile covering is very simple. A silicone welt is sewn all around the individual fabric prints. The prints are simply pressed into the profile and can be changed quickly and easily. Thanks to the frameless look of our systems, the motif is the center of attention, without any disturbing fastening techniques.





ONE TWO **FRAME**

—

SF Adapter Frame

Basic information

Dimensions 6100 x 31 x 9 mm
Weight 280 g/rmt

Description

For shopfitting or conversion of existing frame systems to flat channel system. No stiffening is possible with this profile. The SF Adapter profile is mainly used on objects where other profiles cannot be used due to the circumstances.

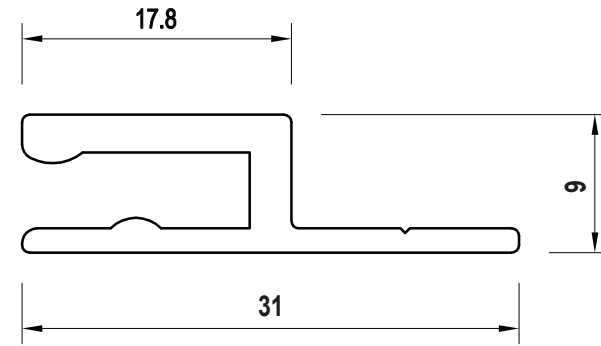

FEATURES

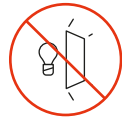

Lighting not possible

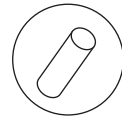

Shipping in tube

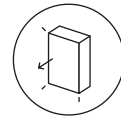

For single sided application

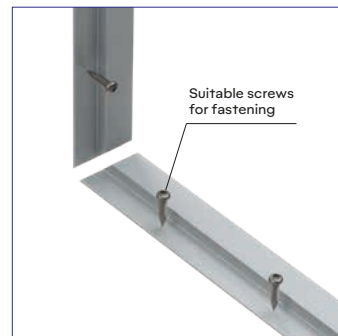

matching accessories

--

SF 17 Frame

Basic information

Dimensions 6100 x 17 x 21 mm
Weight 363 g/rmt

Description

Narrow profile for smaller formats. Preferably for wall mounting. No stiffening possible.

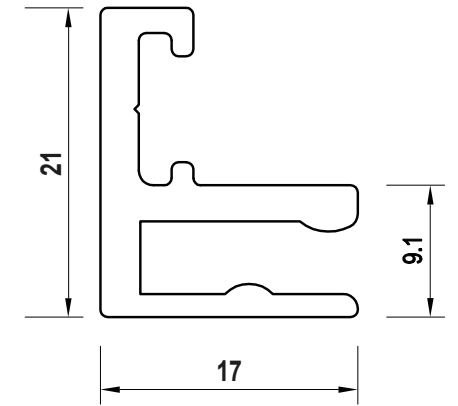

FEATURES

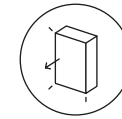

For single sided application

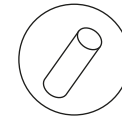

Shipping in tube



Lighting not possible

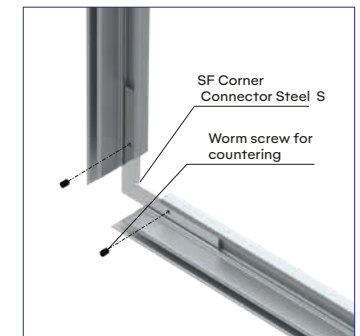

matching accessories

ZR 005 - SF CORNER CONNECTOR STEEL S

SF ADAPTER
FRAME

SF 17
FRAME

SF 23 Frame

Basic information

Dimensions 6100 x 23 x 40 mm
Weight 700 g/rmt

Description

Stable profile with high inherent strength. Preferably for wall mounting. Stiffening possible.

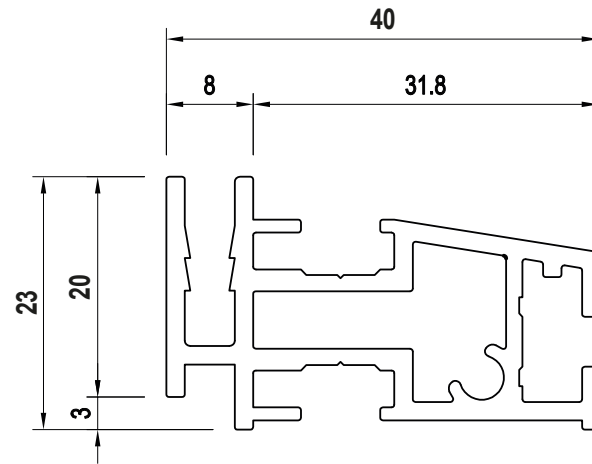

SF 55 DS Frame

Basic information

Dimensions 6100 x 55 x 29 mm
Weight 1038 g/rmt

Description

Double-sided profile for use as screens, ceiling hangers, etc. Use of sound insulation panels up to 40 mm possible. Stiffening possible.

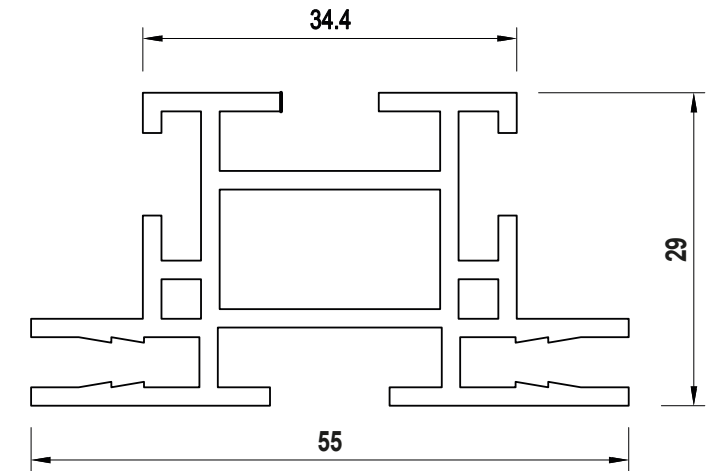

FEATURES

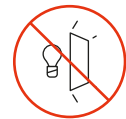

Lighting not possible

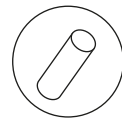

Shipping in tube

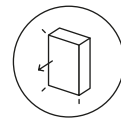

For single sided application

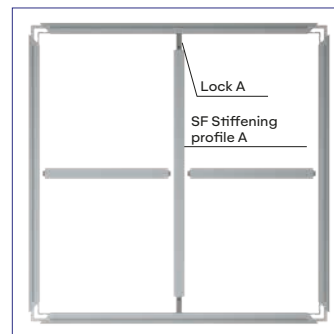
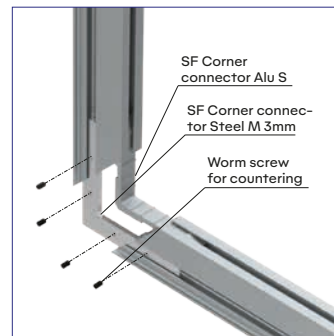

matching accessories

ZR 001 - SF CORNER CONNECTOR ALU S // **ZR 007** - SF CORNER CONNECTOR STEEL M 3mm // **ZR 008** - CONNECTOR STRAIGHT STEEL // **ZR 009** - SF STIFFENING PROFILE A // **ZR 010** - LOCK A



FEATURES

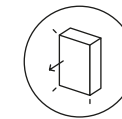

For single sided application

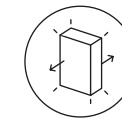

For double sided application

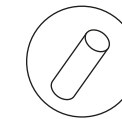

Shipping in tube

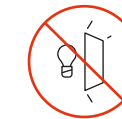

Lighting not possible

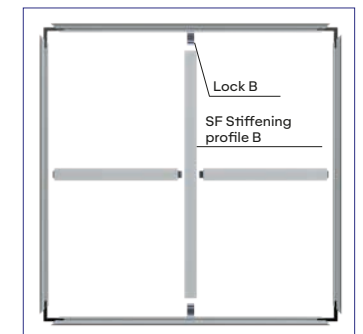
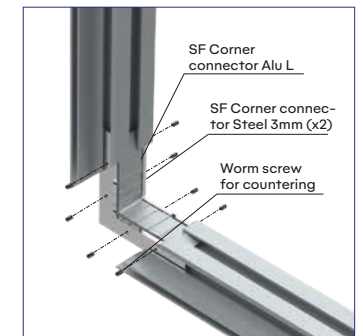

matching accessories

ZR 003 - SF CORNER CONNECTOR ALU L // **ZR 007** - SF CORNER CONNECTOR STEEL M 3mm (x2) // **ZR 008** - CONNECTOR STRAIGHT STEEL (x2) // **ZR 011** - SF STIFFENING PROFILE B // **ZR 012** - LOCK B // **ZR 016** - ACOUSTIC PANEL // **ZR 017** - FOOT S ALU STRAIGHT // **ZR 018** - FOOT M ALU STRAIGHT // **ZR 019** - SF HANGING SET WITHOUT STEEL CABLE // **ZR 020** - STEEL CABLE FOR HANGING SET



SF 23 FRAME

SF 55 DS FRAME

SL 45 Frame

Basic information

Dimensions 6100 x 45 x 25 mm
Weight 655 g/rmt
LED-Modules BL Power, BL LED 45

Description

Slim light box profile for smaller formats (max. 1 x 2 m). No stiffening possible.

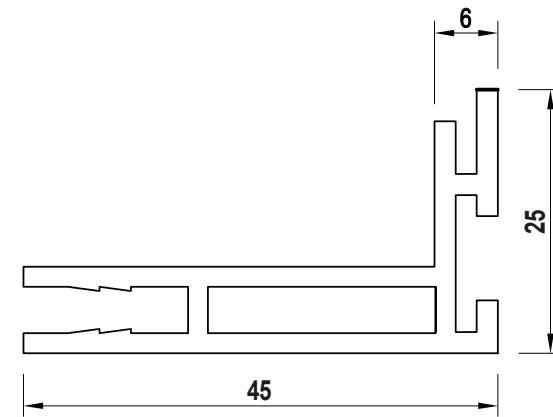

FEATURES

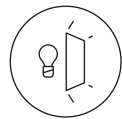

Lighting possible

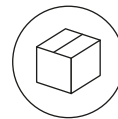

Shipping in box

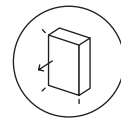

For single sided application

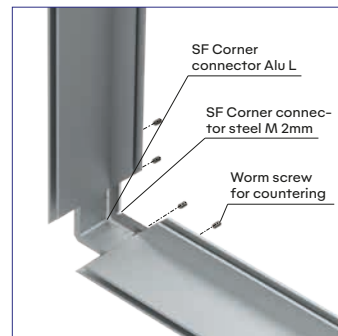

matching accessories

ZR 003 - SF CORNER CONNECTOR ALU L // **ZR 006** - SF CORNER CONNECTOR STEEL M 2mm // **ZR 008** - CONNECTOR STRAIGHT STEEL // **ZR 016** - ACOUSTIC PANEL

SL 60 Frame

Basic information

Dimensions 6100 x 60 x 20 mm
Weight 725 g/rmt
LED-Modules BL Power, BL LED 60

Description

Narrow light box profile for smaller and medium formats (max. 1.5 x 3 m). No stiffening possible.

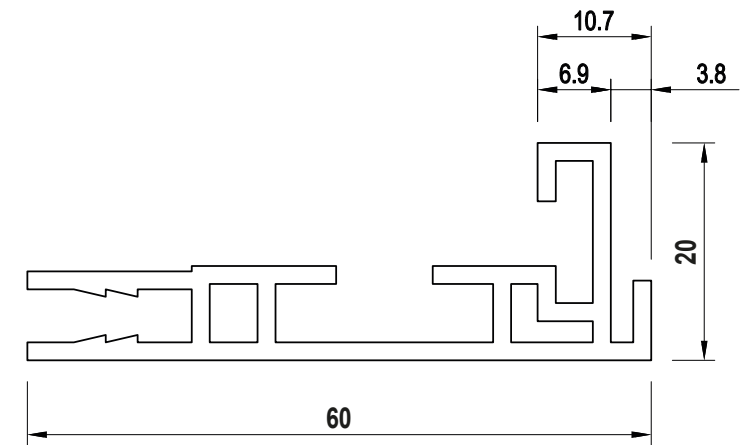

FEATURES

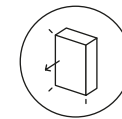

For single sided application

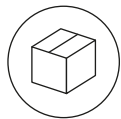

Shipping in box

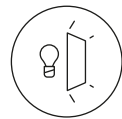

Lighting possible

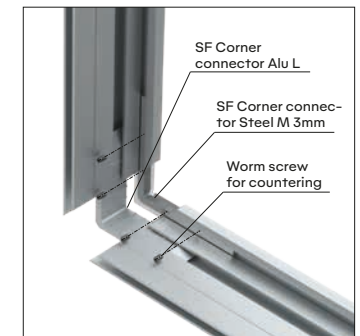

matching accessories

ZR 003 - SF CORNER CONNECTOR ALU L // **ZR 007** - SF CORNER CONNECTOR STEEL M 3mm // **ZR 008** - CONNECTOR STRAIGHT STEEL // **ZR 016** - ACOUSTIC PANEL

SL 45 FRAME

SL 60 FRAME

SL 85 Frame

Basic information

Dimensions 6100 x 85 x 24 mm
Weight 1105 g/rmt
LED-Modules BL Eco, BL LED 85, FL 2020

Description

Solid profile, also suitable for very large formats. Back wall can be used with aluminum or textile. Stiffening possible.

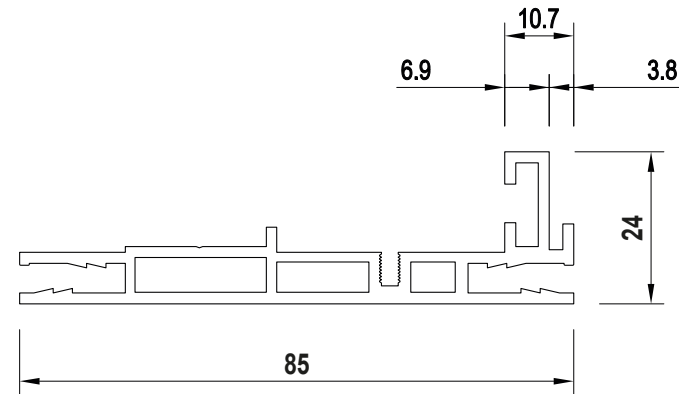

SL 120 Frame

Basic information

Dimensions 6100 x 120 x 32 mm
Weight 1750 g/rmt
LED-Modules BL Eco, FL 2020

Description

Solid profile, also suitable for very large formats. Due to the special keder mounting, this profile is also suitable for outdoor use. Stiffening mandatory.

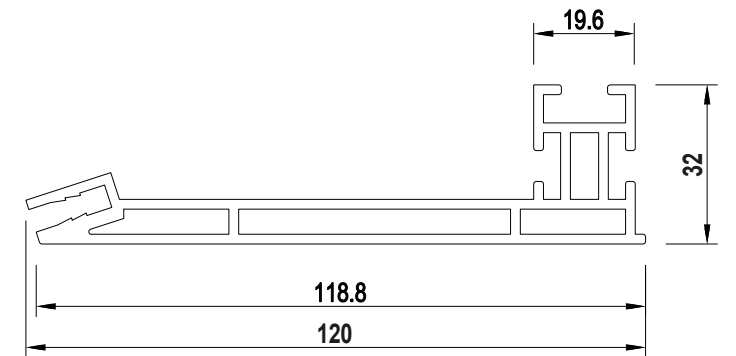

FEATURES

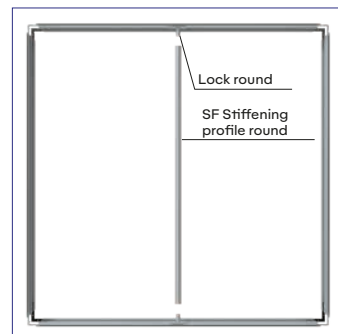
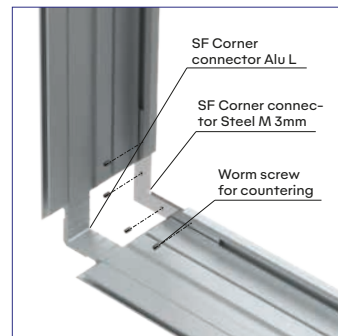
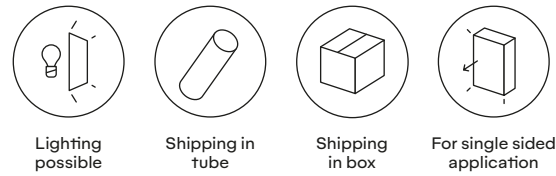

matching accessories

ZR 003 - SF CORNER CONNECTOR ALU L // **ZR 007** - SF CORNER CONNECTOR STEEL M 3mm // **ZR 008** - CONNECTOR STRAIGHT STEEL // **ZR 013** - SF STIFFENING PROFILE ROUND // **ZR 014** - LOCK ROUND // **ZR 015** - CROSS CONNECTOR

FEATURES

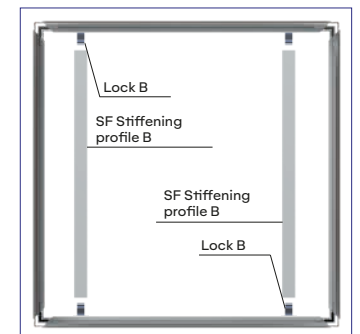
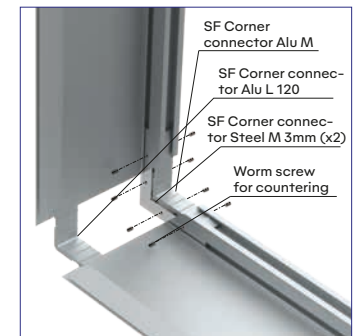
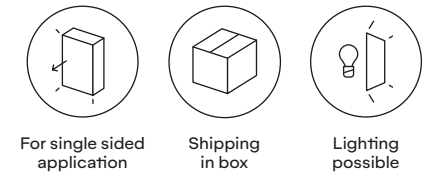

matching accessories

ZR 002 - SF CORNER CONNECTOR ALU M // **ZR 004** - SF CORNER CONNECTOR ALU L 120 // **ZR 007** - SF CORNER CONNECTOR STEEL M 3mm (x2) // **ZR 008** - CONNECTOR STRAIGHT STEEL // **ZR 011** - SF STIFFENING PROFILE B // **ZR 012** - LOCK B

SL 85 FRAME

SL 120 FRAME

SL 120 DS Frame

Basic information

Dimensions 6100 x 120 x 32 mm
Weight 2090 g/rmt
LED-Modules FL 2020

Description

Double-sided profile for use as a screen or ceiling hanger. Stiffening possible.

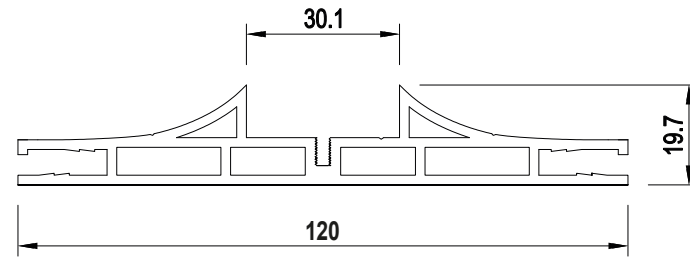

FEATURES

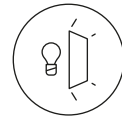

Lighting possible



Shipping in tube

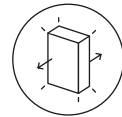

For double sided application

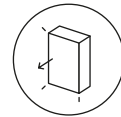

For single sided application

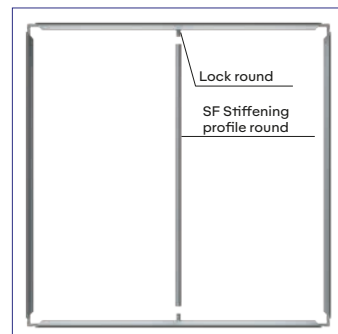
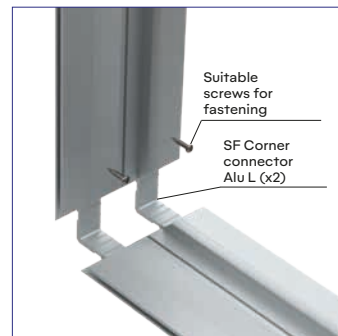

matching accessories

ZR 003 - SF CORNER CONNECTOR ALU L (x2) // **ZR 013** - SF STIFFENING PROFILE ROUND // **ZR 014** - LOCK ROUND // **ZR 015** - CROSS CONNECTOR // **ZR 017** - FOOT S ALU STRAIGHT // **ZR 018** - FOOT M ALU STRAIGHT // **ZR 019** - SF HANGING SET WITHOUT STEEL CABLE // **ZR 020** - STEEL CABLE FOR HANGING SET

COLORFUL? WE ARE TOO.

OUR PROFILES AND FRAMES ARE IN DIFFERENT COLORS AVAILABLE.

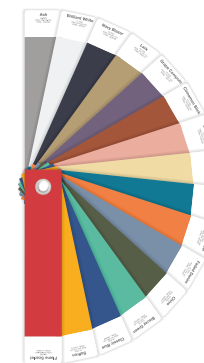

Powder coating possible in RAL colors.

SL 120 DS
FRAME

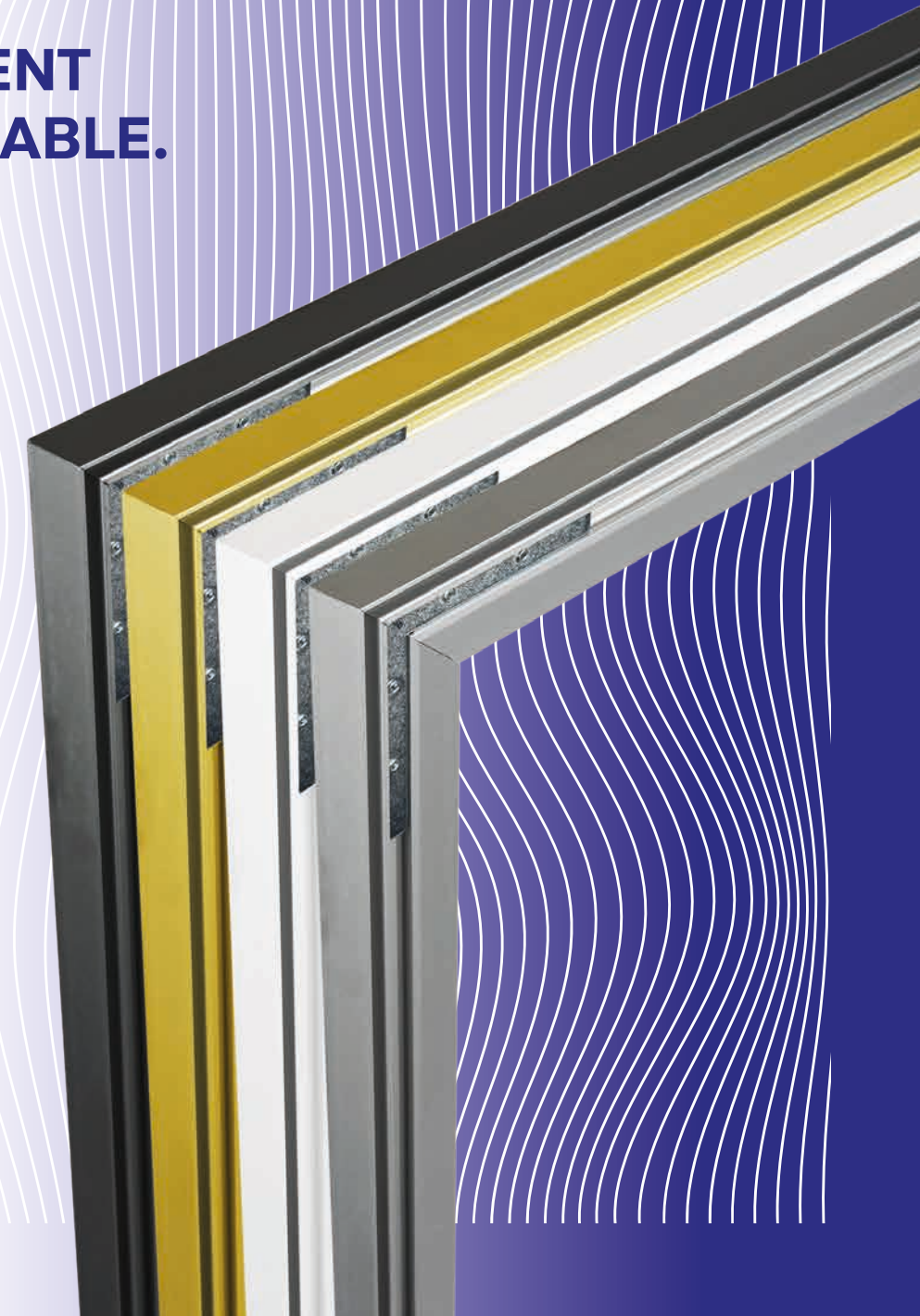

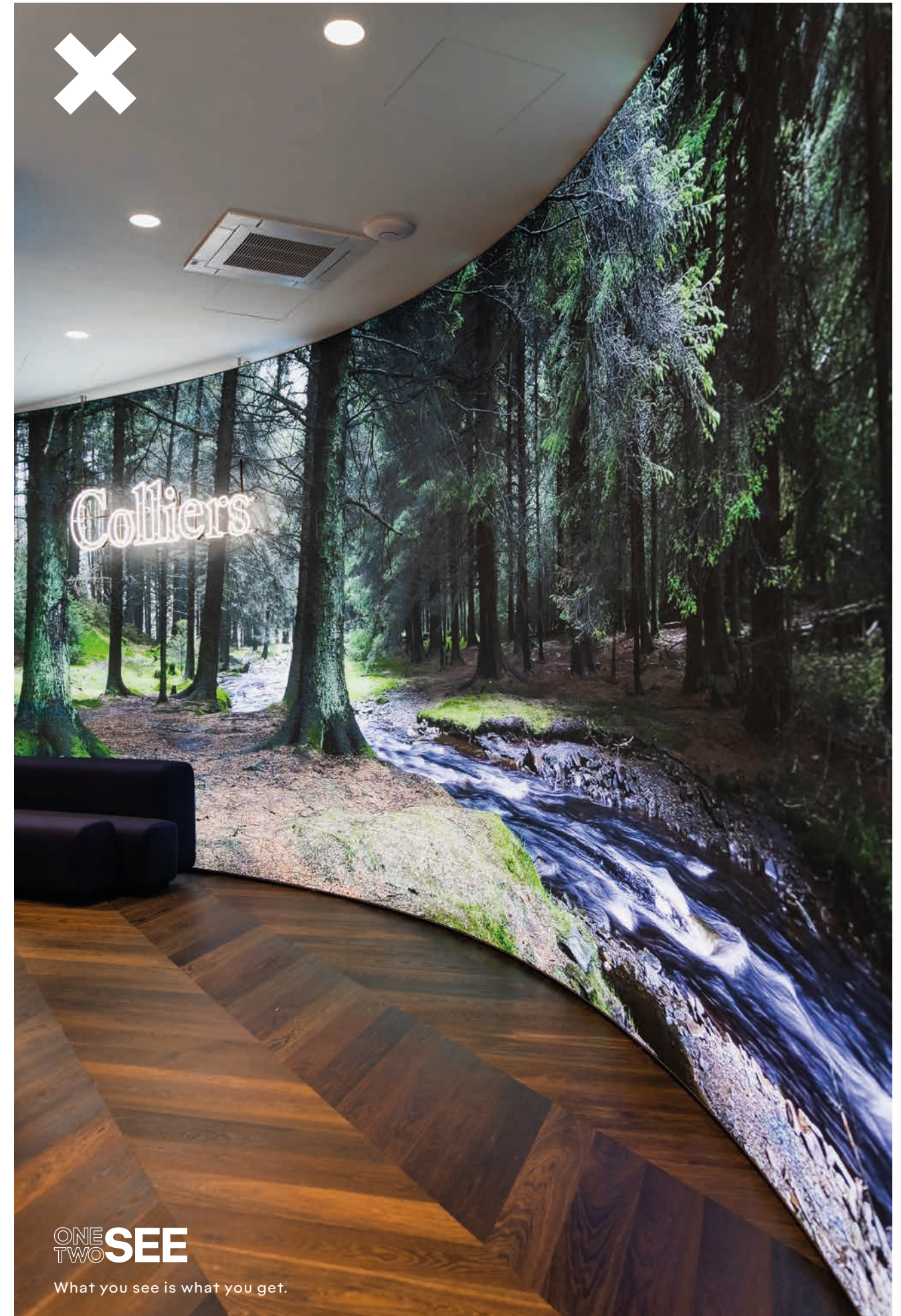



ONE TWO LIGHT

BL LED 45

Basic information

LED type	SMD 2835
Beam angle	170°
Dimmable	yes
Color temperature	approx. 6500 k
Candela	2400 cd/m ²
Power per LED point	1,2 W
Power per m ²	144 W
Voltage	DC 24 V
Luminous flux with optics	approx. 1680 Luminous/rmt
Number of LED points	approx. 120 LED/m ²

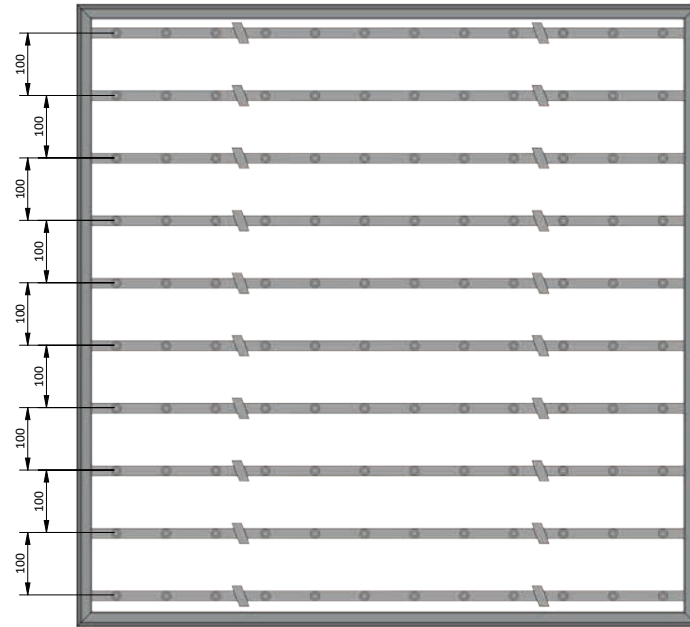

BL LED 60

Basic information

LED type	SMD 2835
Beam angle	170°
Dimmable	yes
Color temperature	approx. 6500 k
Candela	1900 cd/m ²
Power per LED point	1,2 W
Power per m ²	129,6 W
Voltage	DC 24 V
Luminous flux with optics	approx. 1680 Luminous/rmt
Number of LED points	approx. 108 LED/m ²

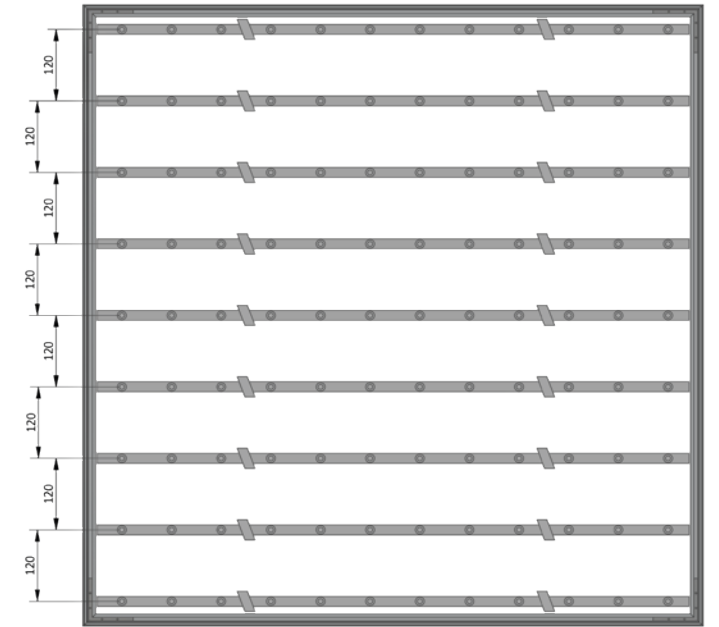

S U I T A B L E
F R A M E S Y S T E M S



SL 45

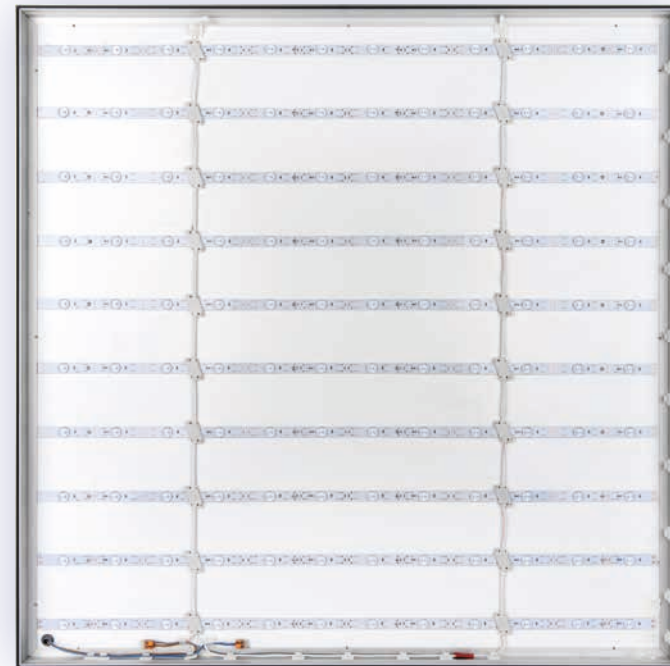

Example of use

BL LED 45 installed in SL 45 frame system, incl. back panel.
ATTENTION: Only for indoor use; Transformer only possible outside the frame!

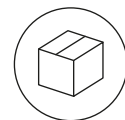

Shipping in box

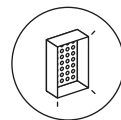

Full-surface Backlighting

S U I T A B L E
F R A M E S Y S T E M S



SL 60



Example of use

BL LED 60 installed in SL 60 frame system, incl. back panel.
ATTENTION: For indoor use only!

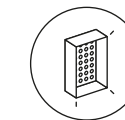

Full-surface Backlighting

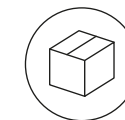

Shipping in box

LED
BL 45

LED
BL 60

BL LED 85

Basic information

LED type	SMD 2835
Beam angle	170°
Dimmable	yes
Color temperature	approx. 6500 k
Candela	approx. 1650 cd/m ²
Power per LED point	1,2 W
Power per m ²	100,8 W
Voltage	DC 24 V
Luminous flux with optics	approx. 1680 Luminous/rmt
Number of LED points	approx. 84 LED/m ²

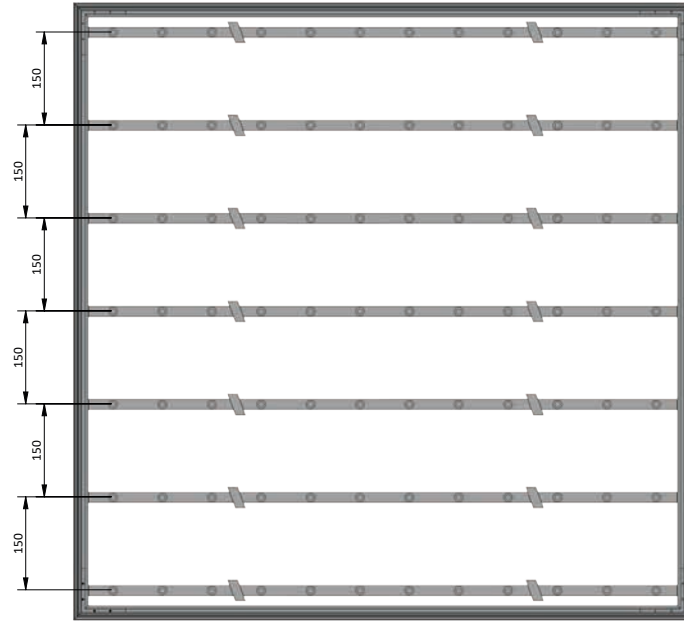

BL ECO LED

Basic information

LED type	SMD 2835
Beam angle	170°
Dimmable	yes
Color temperature	approx. 6500 k
Candela	approx. 600 cd/m ²
Power per LED point	0,72 W
Power per m ²	72 W
Voltage	DC 12 V / DC 24 V
Luminous flux with optics	approx. 650 Luminous/rmt
Number of LED points	approx. 100 LED/m ²

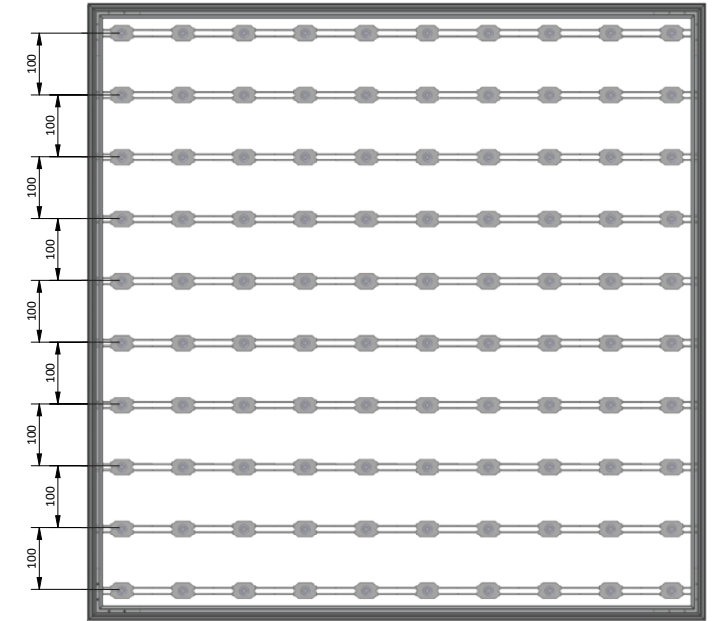

S U I T A B L E
F R A M E S Y S T E M S



SL 85



Example of use

BL LED 85 installed in SL 85 frame system, incl. rear panel.
ATTENTION: For indoor use only!

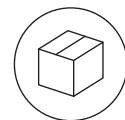

Shipping in box

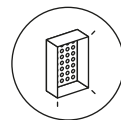

Full-surface Backlighting

S U I T A B L E
F R A M E S Y S T E M S



SL 85



SL 120



Example of use

BL ECO LED installed in SL 85 frame system, incl. back wall. For indoor & outdoor application!

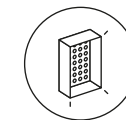

Full-surface Backlighting

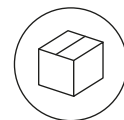

Shipping in box

LED
L
B

LED
L
B

BL POWER LED

Basic information

LED type	SMD 2835
Beam angle	170°
Dimmable	yes
Color temperature	approx. 6500 k
Candela	approx. 1000 cd/m ²
Power per LED point	0,72 W
Power per m ²	103,68 W
Voltage	DC 12 V / DC 24 V
Luminous flux with optics	approx. 780 Luminous/rmt
Number of LED points	approx. 144 LED/m ²

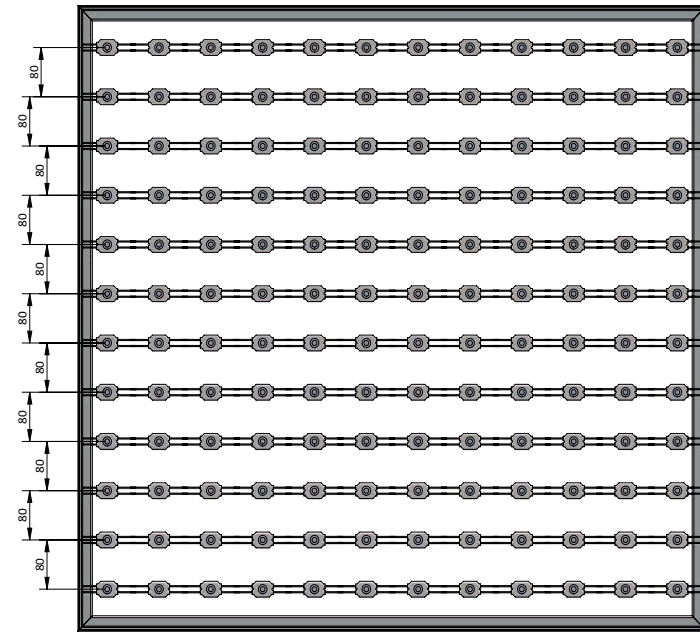

FL 2020

Basisinformation

LED type	OSRAM LED 3030
Beam angle	10° x 36°
Dimmable	yes
Color temperature	approx. 6500 k
Candela	600 cd/m ²
Power per LED point	2 W
Power per rmt	32 W
Luminous flux with optics	approx. 3040 Luminous/rmt
Number of LED points	4 or 16 per Module

Module 4

Format	240 x 26 mm
Power	8 W
Voltage	DC 24 V

Module 16

Format	960 x 26 mm
Power	32 W
Voltage	DC 24 V

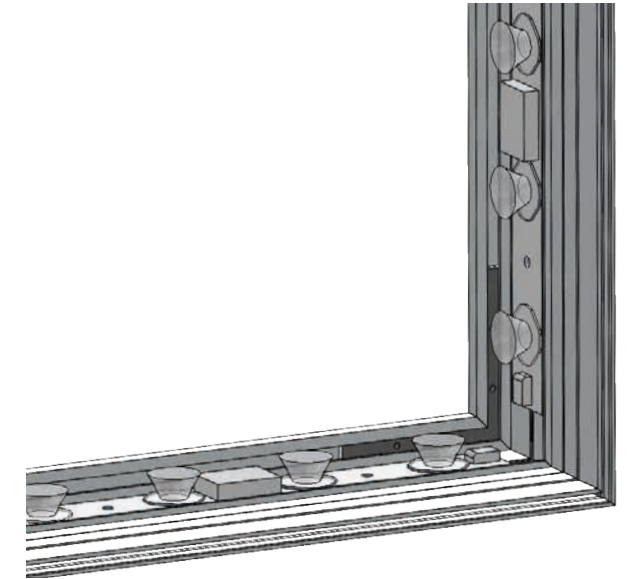

S U I T A B L E
F R A M E S Y S T E M S

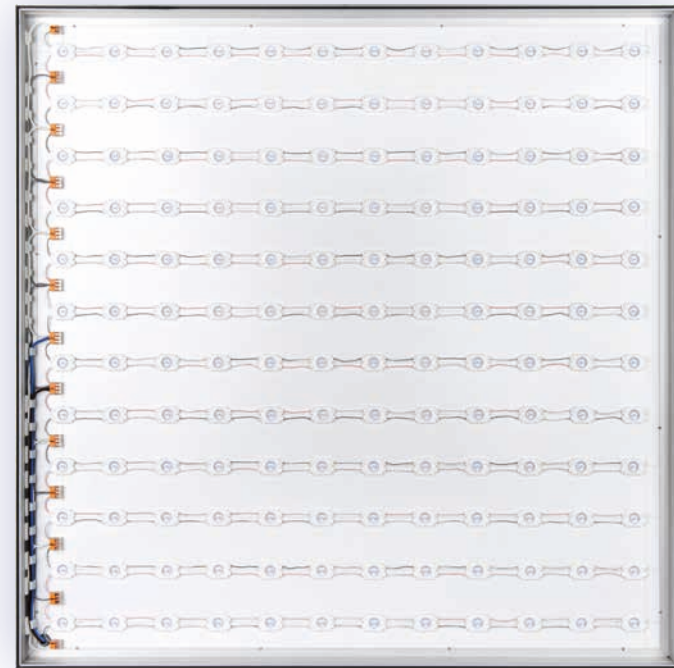
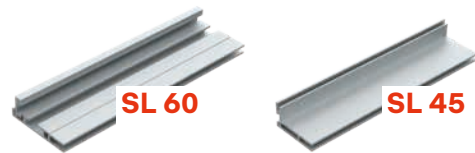

Example of use

BL POWER LED installed in SL 45 frame system, incl. back wall. For indoor & outdoor application!

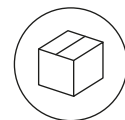

Shipping in box

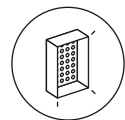

Full-surface Backlighting

S U I T A B L E
F R A M E S Y S T E M S



Example of use

FL 2020 installed in SL 85 frame system, incl. rear panel. The modules consist of one printed circuit board each, which is equipped with 4 or 16 LEDs with mounted optics. **ATTENTION:** Only for indoor application!

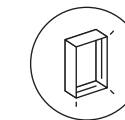

Side lighting



Shipping in tube

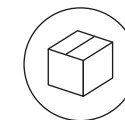

Shipping in box

BL POWER LED

FL 2020

Frame systems accessories



SF Corner Connector Alu S
Material thickness 5,1 mm
60 x 60 x 11 mm, fits SF 23

ZR 001



SF Corner Connector Alu M
Material thickness 5,1 mm
60 x 60 x 16 mm, fits SL 120

ZR 002



SF Corner Connector Alu L
Material thickness 5,1 mm
60 x 60 x 20 mm, fits SF 55 DS, SL 45, SL 60, SL 85, SL 120 DS

ZR 003



SF Corner Connector Alu L 120
Material thickness 4,6 mm
60 x 60 x 19,5 mm, fits SL 120

ZR 004



SF Stiffening Profile Round
White, fits SL 85, SL 120 DS

ZR 013



Lock Round
Fits Stiffening profile round, fits SL 85, SL 120 DS

ZR 014

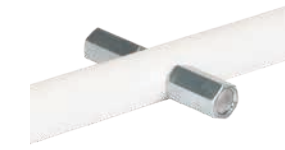

Cross Connector
For stiffening profile round with additional, horizontal stiffening, fits SL 85, SL 120 DS

ZR 015



Acoustic Panel
Sound absorbing panel that can be installed in frames, fits SF 55 DS, SL 45, SL 60

ZR 016



SF Corner Connector Steel S
Material thickness 2 mm
60 x 60 x 10 mm, fits SF 17

ZR 005



SF Corner Connector Steel M 2mm
Material thickness 2 mm
75 x 75 x 12,5 mm, fits SL 45

ZR 006



SF Corner Connector Steel M 3mm
Material thickness 3 mm
75 x 75 x 12,5 mm, fits SF 23, SF 55 DS, SL 60, SL 85, SL 120

ZR 007



Connector Straight Steel
Material thickness 2 mm
100 x 12,5 mm, fits SF 23, SF 55 DS, SL 45, SL 60, SL 85, SL 120

ZR 008



Foot S Alu Straight
Material thickness 8 mm
400 x 80 mm, fits SF 55 DS, SL 120 DS

ZR 017



Foot M Alu Straight
Material thickness 8 mm
600 x 80 mm, fits SF 55 DS, SL 120 DS

ZR 018



SF Hanging Set without Steel Cable
2-piece (1 pc. wall + 1 pc. profile), fits SF 55 DS, SL 120 DS

ZR 019



Steel Cable for Hanging Set
Material thickness 1,5 mm
fits SF 55 DS, SL 120 DS

ZR 020



SF Stiffening Profile A
16 x 40 mm, fits SF 23

ZR 009



Lock A
Fits Stiffening profile A, fits SF 23

ZR 010



SF Stiffening Profile B
19 x 45 mm, fits SF 55 DS, SL 120

ZR 011



Lock B
Fits Stiffening profile B, fits SF 55 DS, SL 120

ZR 012



Roller for Rubber Welt Flat
Allows easy mounting of pictures with flat rubber welt

ZR 021



Roller for Rubber Welt Round
Allows easy mounting of pictures with round rubber welt

ZR 022



Rubber Welt Round
Alternative welt for pictures without sewn flat welt

ZR 023



Mounting Gloves "Light and Frame"
Special gloves for welt mounting, fast, easy & stain resistant.

ZR 024



Light & Frame

NOTES?
FEEL FREE

TREVISION

TREVISION

TREVISION

TREVISION

TALK TO US

TREVISION Groß.Bild.Technik GmbH
Industriestraße 1
7051 Großhöflein, Austria

T +43 2682 76060-0
E info@trevision.at
G www.trevision.at
